

pelipal

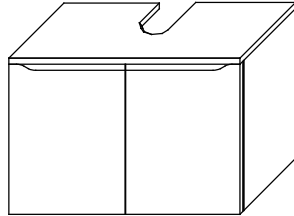

MOT-NZ0956S1 | A4
Datum 29/05/19

3__ - 016017

T1 Bitte unbedingt ausfüllen!

Name _____
Strasse _____
Plz _____ Ort _____
Tel. _____

T2 Sehr geehrte Kunden,
wir freuen uns, dass Sie sich für ein Produkt aus dem Hause Pelipal entschieden haben. Sollte es trotz aller Bemühungen unsererseits, Ihnen ein qualitativ hochwertiges Möbelstück zu liefern, zu Fehlteilen kommen, schicken Sie bitte dieses ausgefüllte Blatt an
Fax.: **+49 3443/434350**
E-Mail: **ersatzteile@pelipal.de**
Bitte beachten Sie, dass Bauteile über 800mm Länge und 350mm Breite direkt bei Ihrem Möbelhändler zu beanstanden sind. Zur Reklamationsbearbeitung ist es unbedingt erforderlich **die Artikelnummer des Schrankes**, welche auf dem Etikett ersichtlich ist und den Markt, wo das Möbel erworben wurde anzugeben. Außerdem tragen Sie unten bitte die benötigte Stückzahl ein. Viel Spaß mit Ihrem neuen Badmöbel! Ihr Pelipal Team

_____ - _____

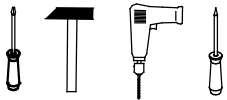





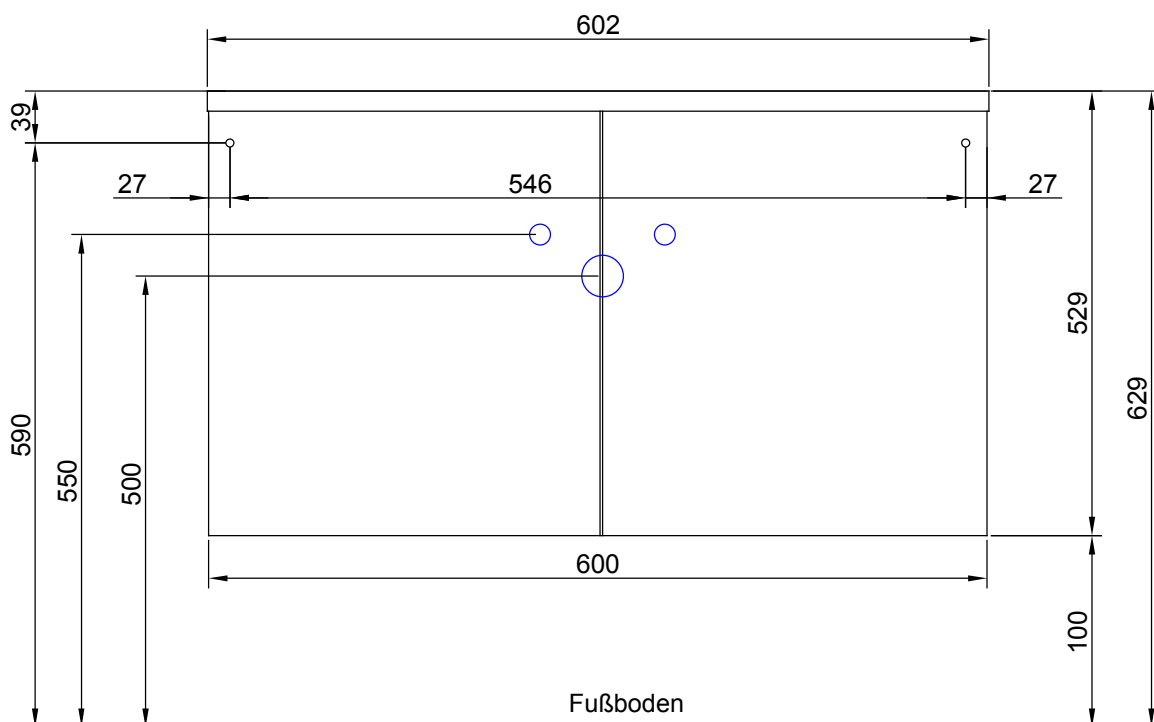

T3 Für den Zusammenbau sind 2 Personen erforderlich.

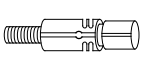
T4 Montage-Richtzeit 3 Stunden

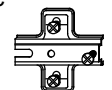
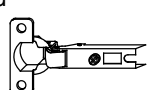
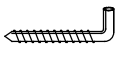
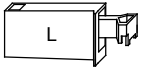
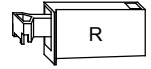

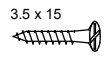
Die Maßangabe der Höhe ist nicht bindend!

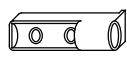
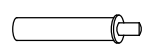
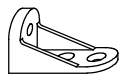
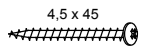
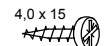
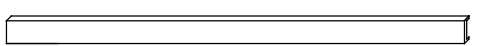
10 x a  DUEB-SMD-000005	Stück	10 x b  EXZENTER-000015	Stück	4 x c  ZPL-003X004	Stück	4 x d  TBD-35-115X00	Stück	2 x e  AUF-001-000020	Stück
1 x f  AUF-001-000090	Stück	1 x g  AUF-001-000080	Stück	2 x h  DUEB-HLZ-008X030	Stück	4 x j  ADK-WE1-035X038	Stück	14 x k  SCH-SPA-035X015	Stück
10 x l  NAGEL-025X001	Stück	2 x m  RWD-KEI-000060	Stück	2 x n  TUER-ADA-000010	Stück	2 x o  TUER-DAEM-000010	Stück	1 x p  VBD-000020	Stück
1 x r  SCH-RDK-045X045	Stück	1 x s  SCH-RDK-040X015	Stück	1 x t  Kantenprofil	Stück		Stück		Stück

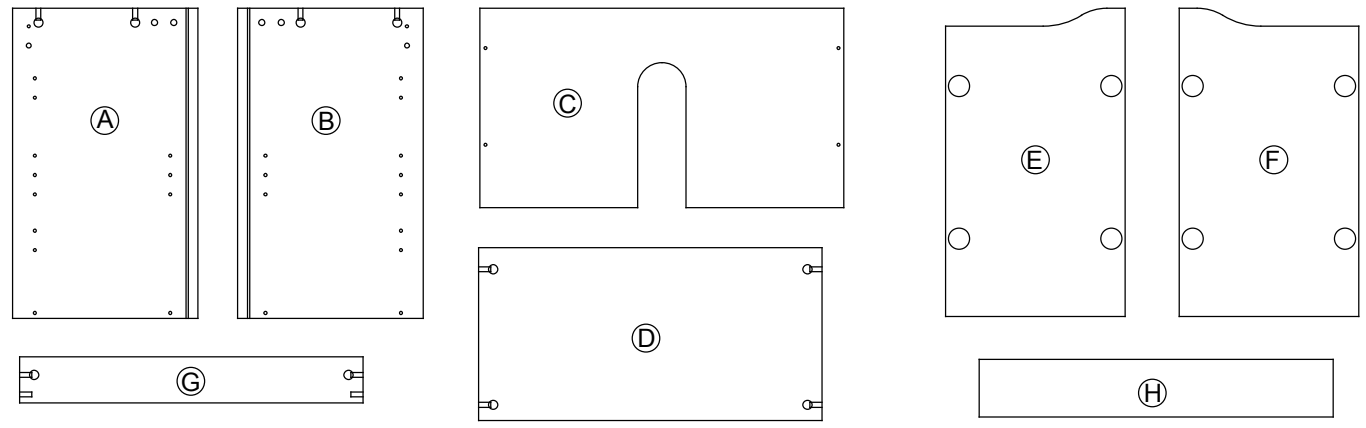

1.

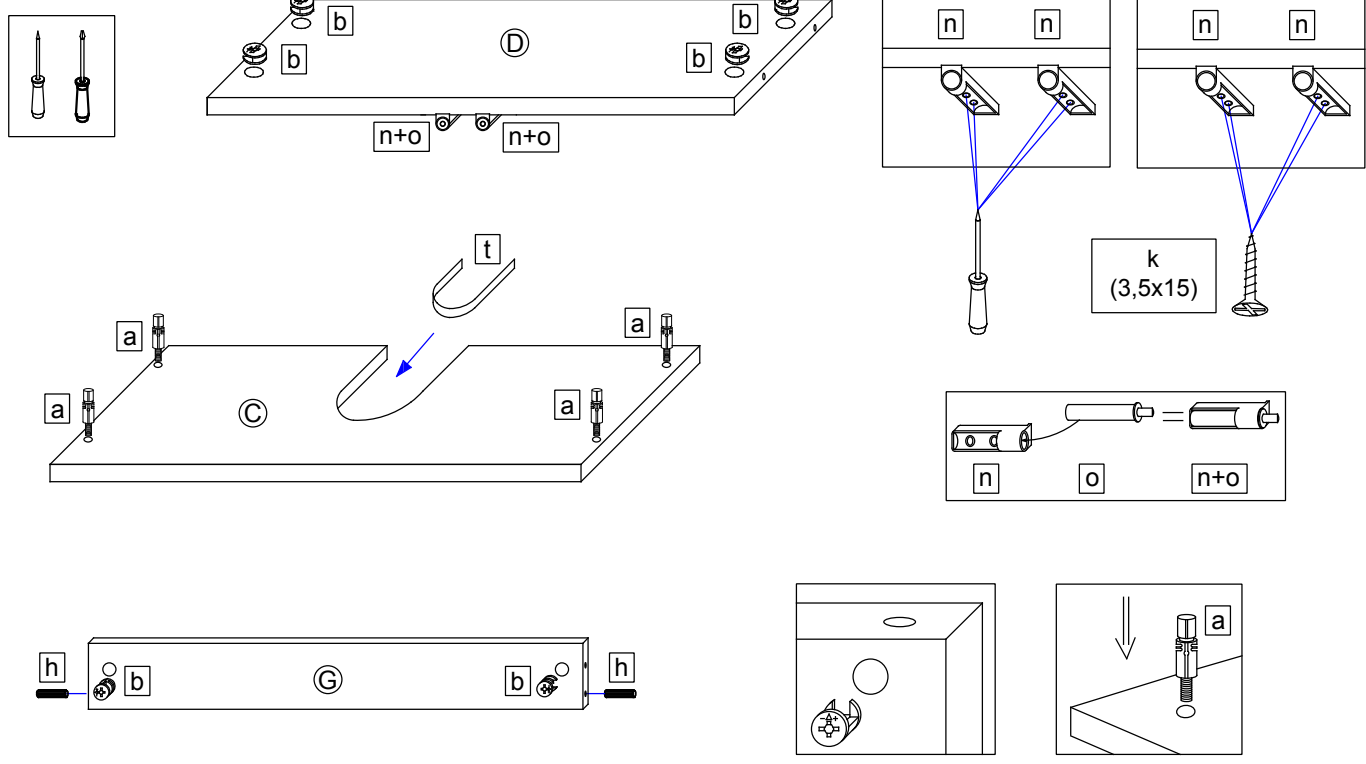

2.

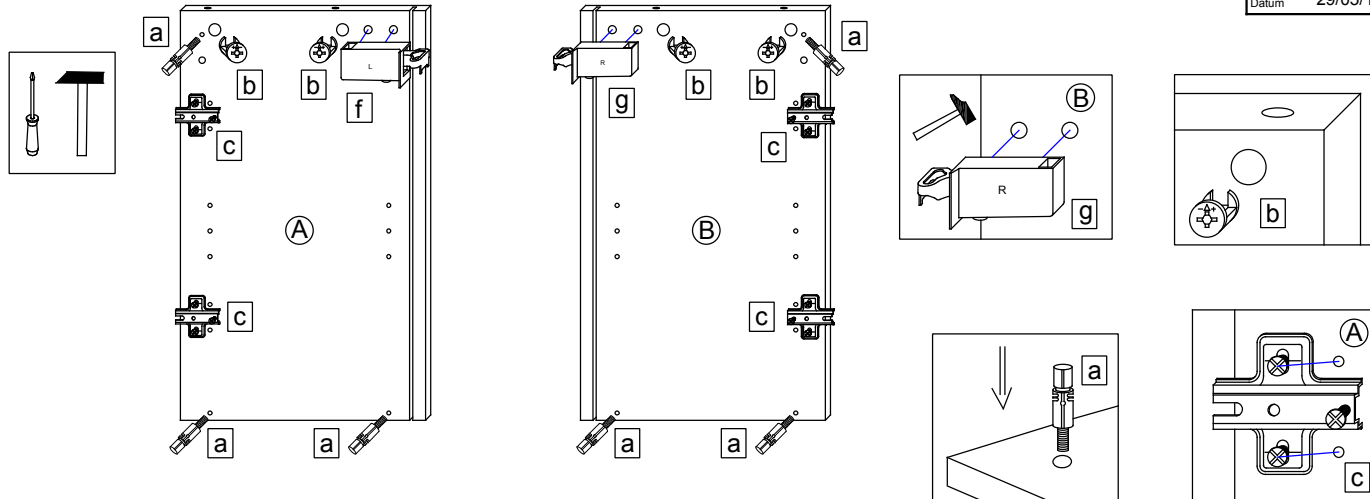

3.

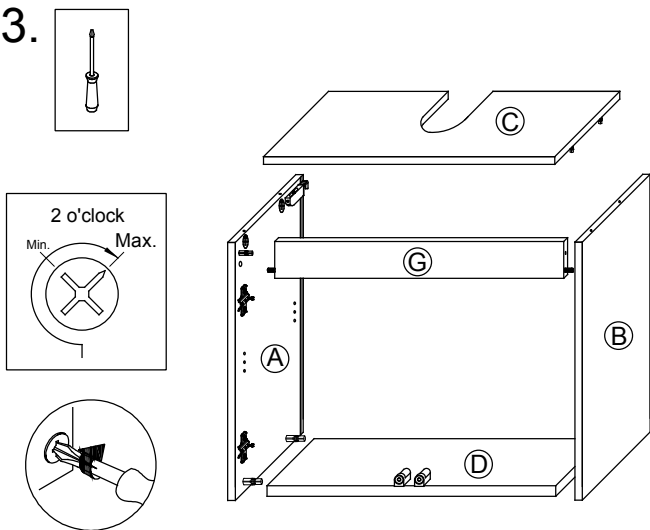

4.

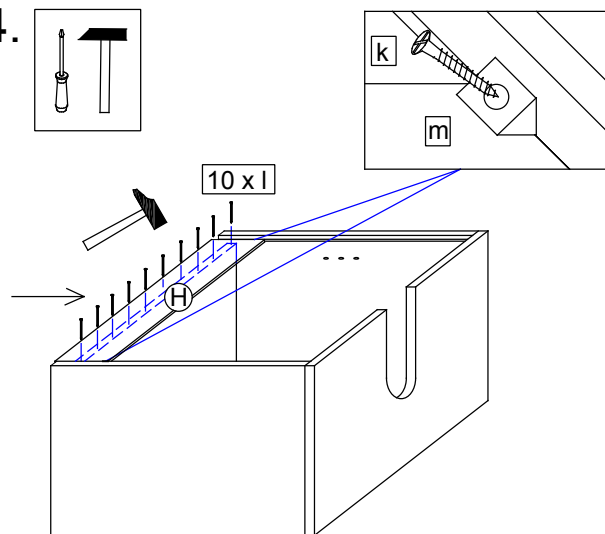

5.

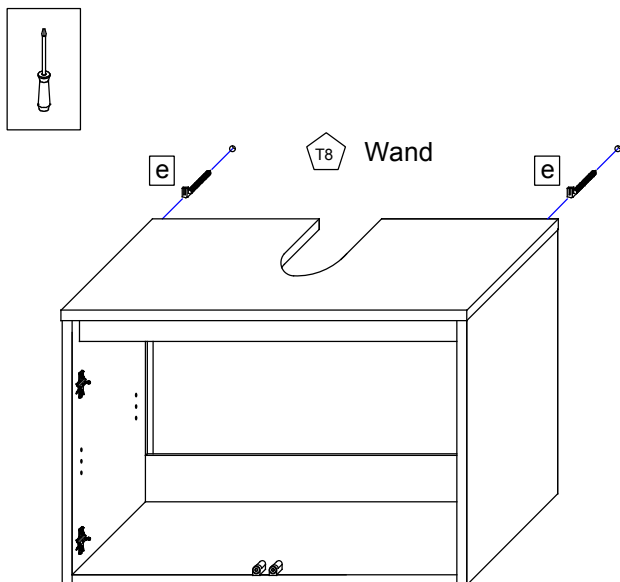

T6 Die Schrankaufhänger dienen zur Kippsicherung des Schrankes und müssen grundsätzlich montiert werden.



T9 Lassen Sie den Schrank nur durch fachkundige Personen mit für die Wand geeignetem Montagematerialien montieren.

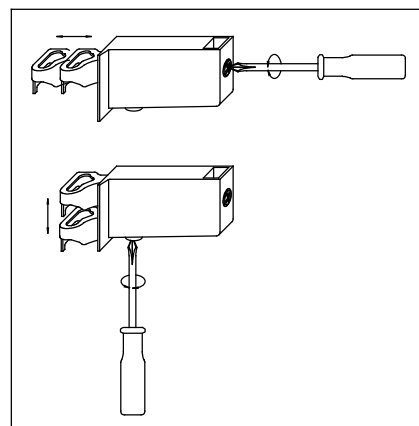
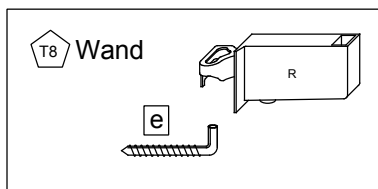

6.

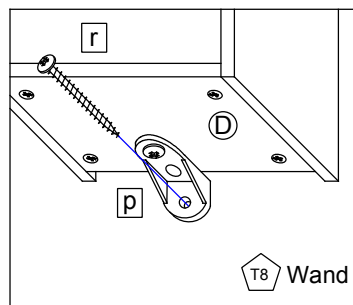
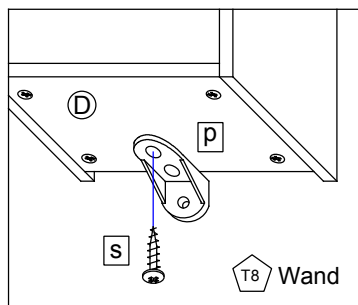
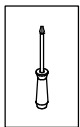

T8 Wand

T8 Wand

7.

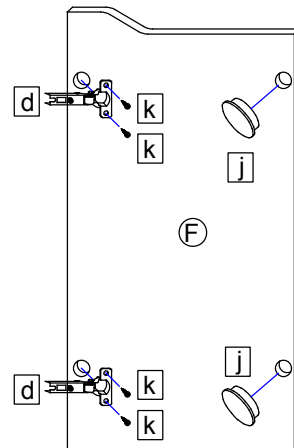
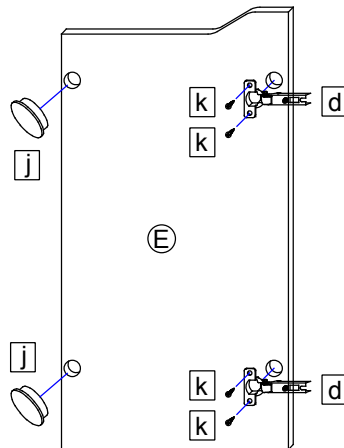
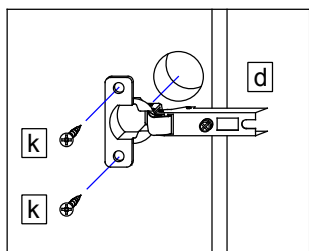
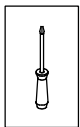

8.

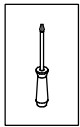

T11

Bei Türmontage das Scharnier einhängen, bis Anschlag öffnen und anschließend festschrauben.

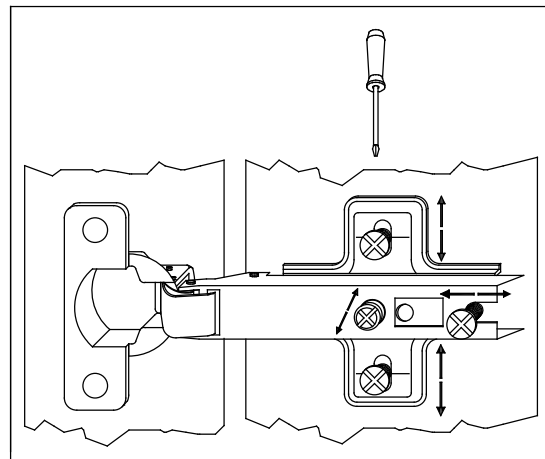
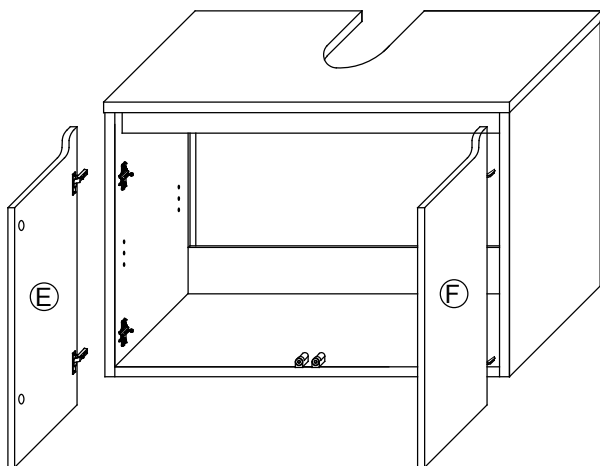
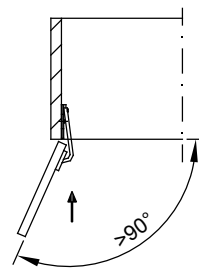

T12

Das Möbel bitte nur mit einem feuchten Tuch reinigen.